

SWAN model SW-307 Single stage 3 cyl. air cooled

Rev.
No. CS0308-SW307

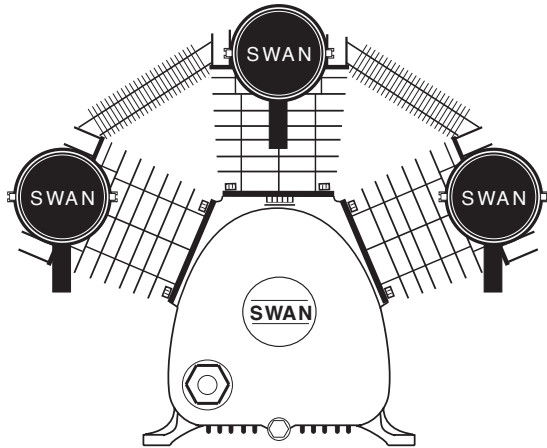

SW-307 PERFORMANCE

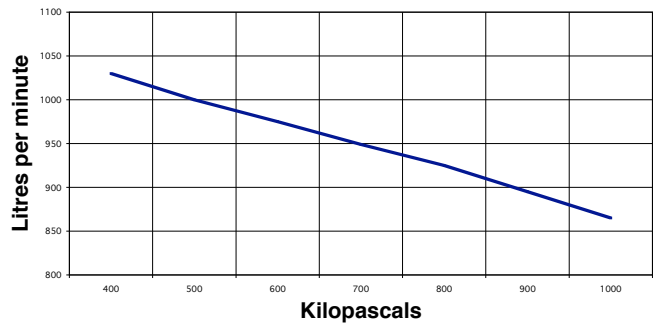

Main Construction Material	Cast Iron	<i>The following are at normal speed with an ambient temperature of 31.1°C & inlet air of 101 kPa g pressure.</i>			
Bore	mm	82	Piston Displacement	L/min	1265
Stroke	mm	85	Free Air Delivery @ 689 kPa	L/min	949
Minimum Speed	rpm	690	Shaft Input:		
Normal Speed	rpm	940	@ 415 kPa	kW	4.76
Maximum Speed	rpm	1110	@ 551 kPa	kW	5.48
Minimum Working Pressure	kPa	275	@ 689 kPa	kW	5.94
Maximum Working Pressure	kPa	964	@ 964 kPa	kW	6.87
Minimum Ambient Temperature	Celsius	0°	Temperature of Air Discharge:		
Maximum Ambient Temperature	Celsius	45°	@ 415 kPa	Celsius	103°
Air Connection Comp. Fitting (x2)	mm	25	@ 551 kPa	Celsius	112°
Air Cleaners	Dry Paper Type		@ 689 kPa	Celsius	120°
Bore Lubrication	Splash Feed		@ 964 kPa	Celsius	146°
Oil Capacity of Crankcase	Litres	1.980	Maximum Lubricant Consumed		
Type of Drive	V-belt	3B	in 100 hours Operation	millilitre	82.93
Approximate Net Weight	kgs	92	Noise Level at 1 metre	dB(A)	85
Rotation Looking at Flywheel	Anti-clockwise				

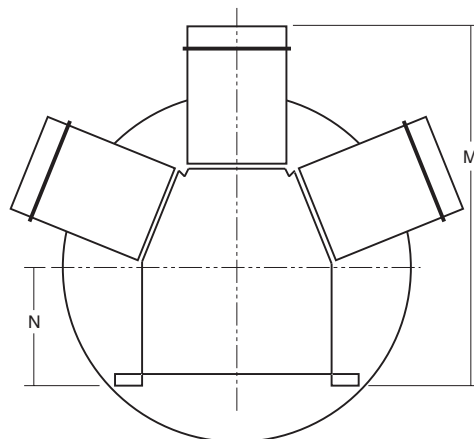
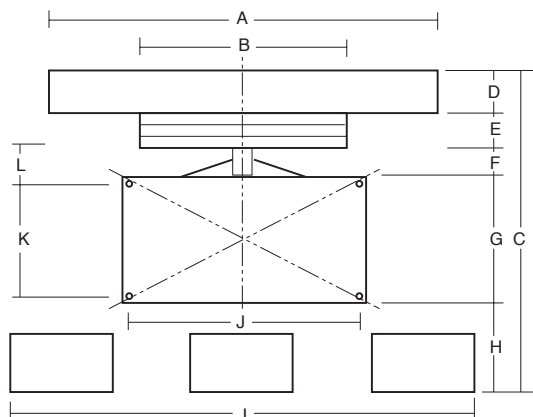

A	560 mm
B	250 mm
C	520 mm
D	60 mm
E	67 mm
F	65 mm
G	215 mm
H	53 mm
I	670 mm
J	275 mm
K	180 mm
L	100 mm
M	540 mm
N	180 mm

Forbes (Aust) Pty Ltd reserves the right to change the specifications of any of its products without prior notice