

CONNECTION	DESCRIPTION	SIZE
A	STEAM OUTLET	DN40
B	FEED WATER	DN15
C	SAFETY VALVE DISCHARGE	DN20
D	BLOWDOWN (BOILER)	DN25
E	BLOWDOWN (WATER COLUMN)	DN20
F	BLOWDOWN (SIGHT GLASS)	DN15
G	GAS INLET	DN32
H	FLUE CONNECTION	305 DIA
J	INSPECTION HANDHOLES & FLANGE	
K	CLEAN OUT DOOR (FLUE PASS)	

ALL DN CONNECTIONS BSPT

STEAM OUTPUT 480 KG/HR
 STANDARD OPERATING PRESSURE 10.34 BARG
 WATER CONTENT 640 LITRES

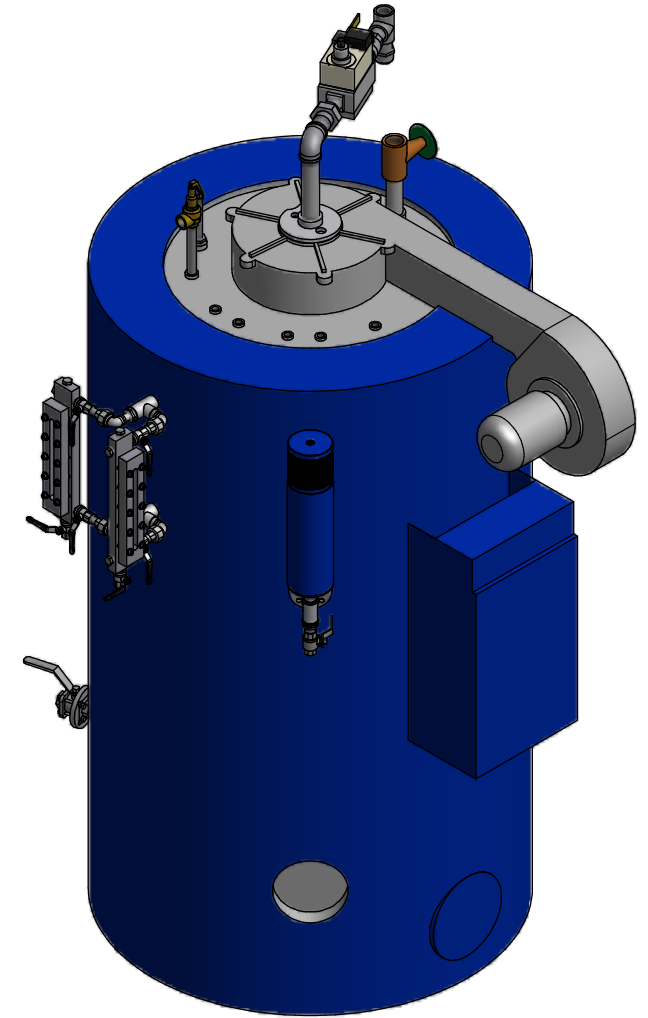
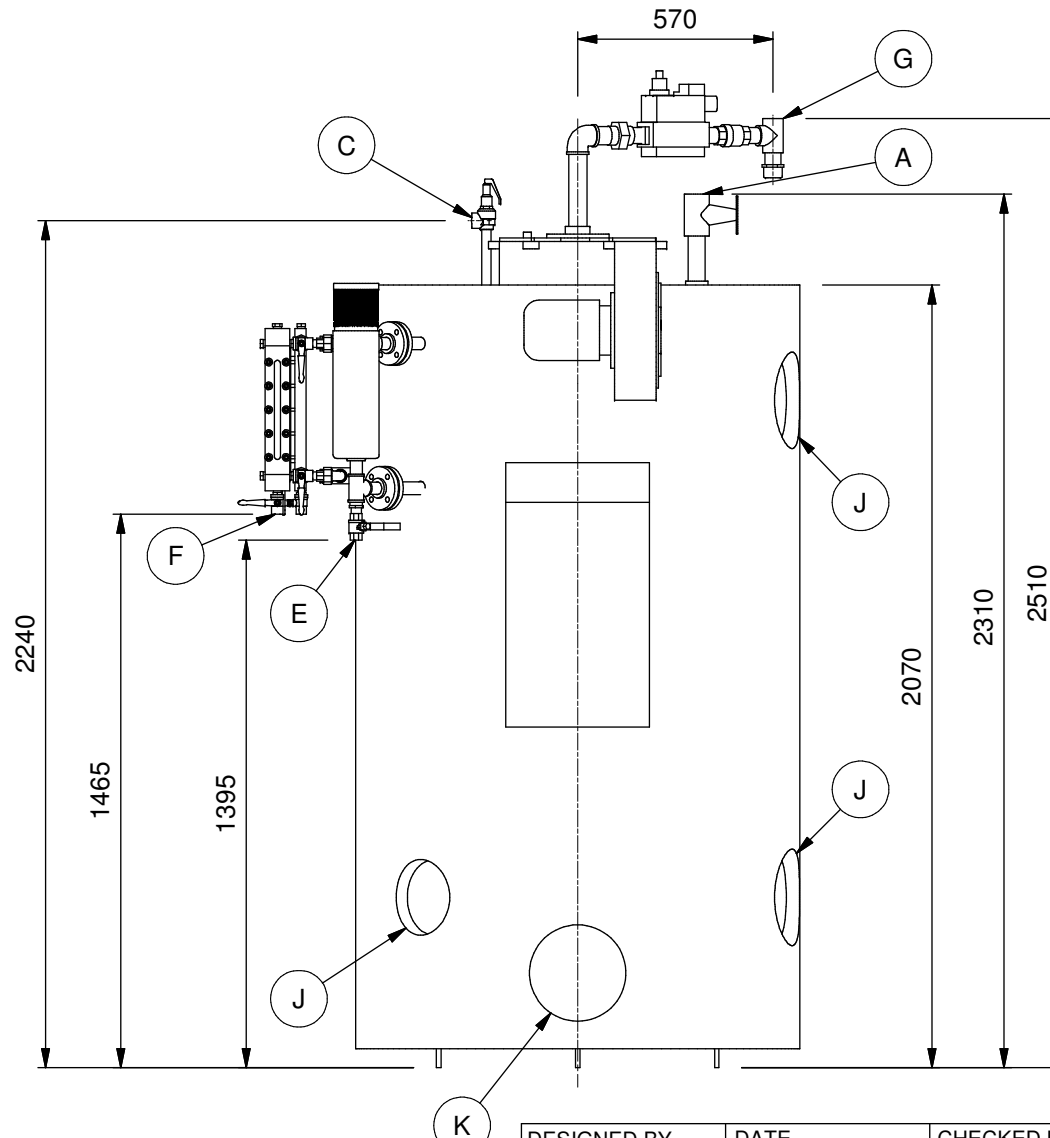
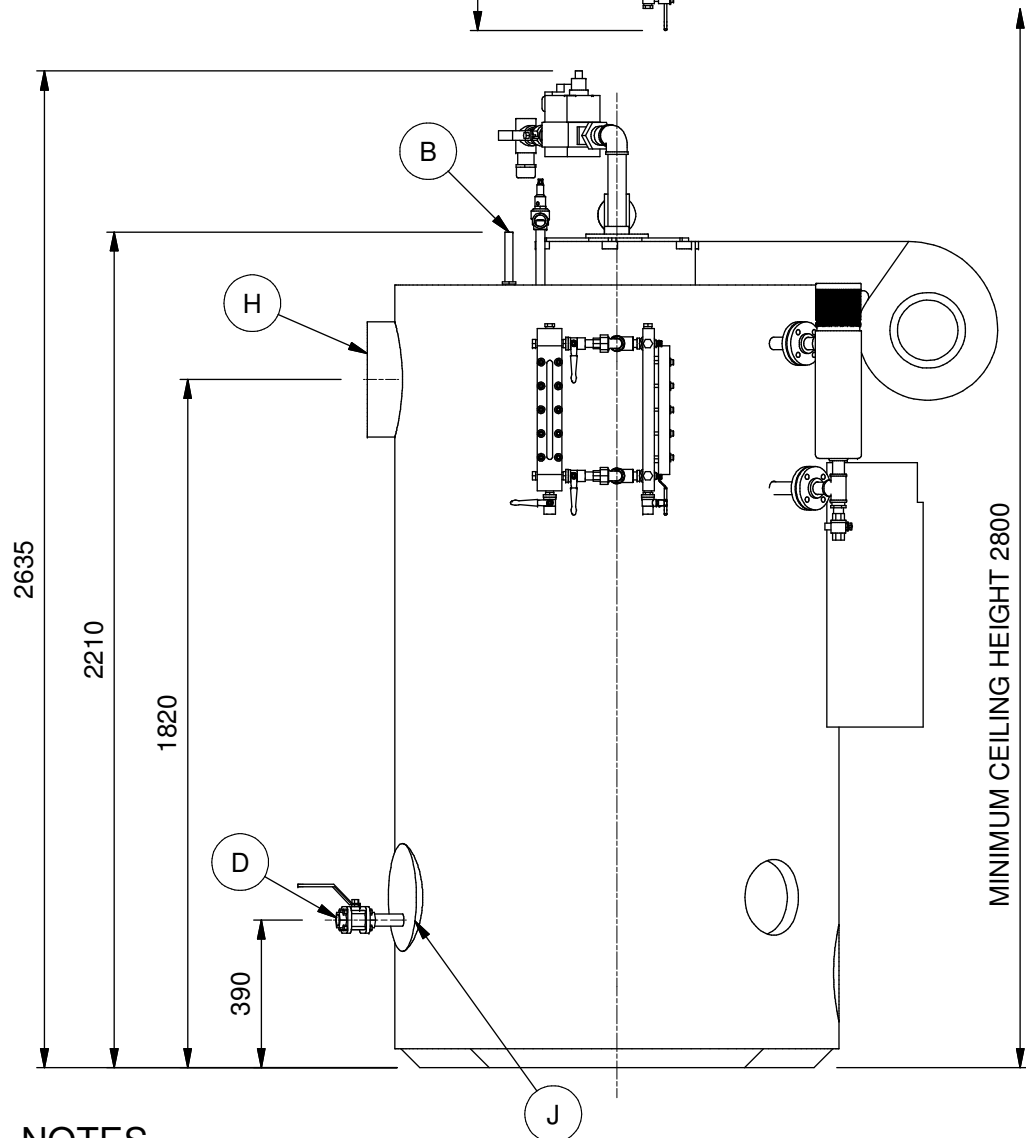

NOTES

1. DUE TO TOLERANCING DIMENSIONS MAY VARY
2. ENSURE ADEQUATE ACCESS TO INSPECTION OPENINGS & FLANGES

DESIGNED BY CT	DATE 27/08/2010	CHECKED BY MM	APPROVED BY PK	SCALE 1:20	SHT SIZE A3	REVISION -
GAS FIRED 30J BOILER INSTALLATION			Fulton Boiler Works (GB) Ltd.			
			PART N°: 030JG140UK	DRAWING N°: F10029	SHEET 1 OF 1	